

2MP WDR LightHunter Vandal-resistant Fixed Dome Network Camera

IPC322ER3-DUVPF28(40)-C

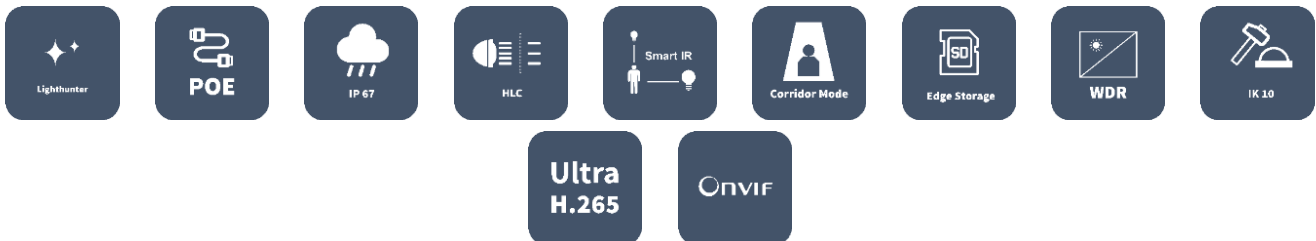

Key Features



Optics

- LightHunter
- Day/night functionality
- Smart IR, up to 30m (98ft) IR distance
- Car-grade LEDs, brighter and uniform light compensation
- Up to 120 dB WDR (Wide Dynamic Range)
- 2D/3D DNR (Digital Noise Reduction)

Compression

- Ultra 265, H.265, H.264, MJPEG
- Embedded smart algorithm

- Triple streams
- ROI (Region of Interest)
- Customized OSD

Network

- ONVIF Conformance

Structure

- Wide temperature range: -35°C ~ 60°C (-31°F ~ 140°F)
- Wide input voltage range of ±25%
- IK10 vandal resistant
- IP67
- 3-Axis

Specifications

	IPC322ER3-DUVPF28-C	IPC322ER3-DUVPF40-C			
Camera					
Sensor	1/2.8", 2.0 megapixel, progressive scan, CMOS				
Lens	2.8mm@F1.6		4.0mm@F1.6		
DORI Distance	Lens (mm)	Detect (m)	Observe (m)	Recognize (m)	Identify (m)
	2.8	45	18	9	4.5
	4.0	64.3	25.7	12.9	6.4
Angle of View (H)	107.8°		82.0°		
Angle of View (V)	56.7°		41.4°		
Angle of View (O)	140.2°		100.9°		
Adjustment angle	Pan: 0° ~ 360°		Tilt: 0° ~ 75°		Rotate: 0° ~ 360°
Shutter	Auto/Manual, 1 ~ 1/100000s				
Minimum Illumination	Colour: 0.001Lux (F1.6, AGC ON) 0Lux with IR				
Day/Night	IR-cut filter with auto switch (ICR)				
S/N	>52dB				
IR Range	Up to 30m (98ft) IR range				
wavelength	850nm				
IR On/Off Control	Auto/Manual				
Defog	Digital Defog				
WDR	120dB				
Video					
Video Compression	Ultra 265, H.265, H.264, MJPEG				
H.264 code profile	Baseline profile, Main Profile, High Profile				
Frame Rate	Main Stream: 2MP (1920*1080), Max 30fps; Sub Stream: 2MP (1920*1080), Max 30fps;				

	Third Stream: D1 (720*576), Max 30fps
Video Bit Rate	128 Kbps~16 Mbps
9:16 Corridor Mode	Supported
OSD	Up to 8 OSDs
Privacy Mask	Up to 8 areas
ROI	Up to 8 areas
Motion Detection	Up to 4 areas
Image	
White Balance	Auto/Outdoor/Fine Tune/Sodium Lamp/Locked/Auto2
Digital noise reduction	2D/3D DNR
Smart IR	Support
Flip	Normal/Vertical/Horizontal/180°/90°Clockwise/90°Anti-clockwise
Dewarping	N/A
HLC	Support
BLC	Support
Smart	
Behavior Detection	Intrusion, cross line, motion detection
Intrusion	Enter and loiter in a pre-defined virtual region
cross line	Cross a pre-defined virtual line
motion detection	Moving within a pre-defined virtual region
Recognition	Face detection, Audio detection
Intelligent Identification	Defocus, Scene Change, Object Left, Object Moving
Statistical Analysis	People counting
General Function	Watermark, IP Address Filtering, Tampering Alarm, Alarm input, Alarm output, Access Policy, ARP Protection, RTSP Authentication, User Authentication
Audio	
Audio Compression	G.711
Two-way audio	Supported
Suppression	Supported
Sampling Rate	8KHZ
Storage	
Edge Storage	Micro SD, up to 256GB
Network Storage	ANR, NAS(NFS)
Network	
Protocols	IPv4, IGMP, ICMP, ARP, TCP, UDP, DHCP, PPPoE, RTP, RTSP, RTCP, DNS, DDNS, NTP, FTP, UPnP, HTTP, HTTPS, SMTP, 802.1x, SNMP, QoS
Compatible Integration	ONVIF (Profile S, Profile G, Profile T), API
Client	EZStation EZView EZLive
Web Browser	Plug-in required live view: IE9+, Chrome 41 and below, Firefox 52 and below
	Plug-in free live view: Chrome 57.0+, Firefox 58.0+, Edge 16+, Safari 11+
Interface	
Audio I/O	Input: impedance 35kΩ; amplitude 2V [p-p]
	Output: impedance 600Ω; amplitude 2V [p-p]

Alarm I/O	1/1
Network	1 RJ45 10M/100M Base-TX Ethernet
Certifications	
Certifications	CE: EN 60950-1 UL: UL60950-1 FCC: FCC Part 15
General	
Power	DC 12V±25%, PoE (IEEE 802.3af)
	Power consumption: Max 4W
Dimensions (∅ x H)	∅108.5 x 81mm (∅4.28" x 3.2")
Net Weight	0.45kg (0.99lb)
Material	Metal + Plastic
Working Environment	-35°C ~ 60°C (-31°F ~ 140°F), Humidity: ≤95% RH (non-condensing)
Storage Environment	-35°C ~ 60°C (-31°F ~ 140°F), Humidity: ≤95% RH (non-condensing)
surge protection	2KV
Ingress Protection	IP67
Vandal Resistant	IK10

Dimensions

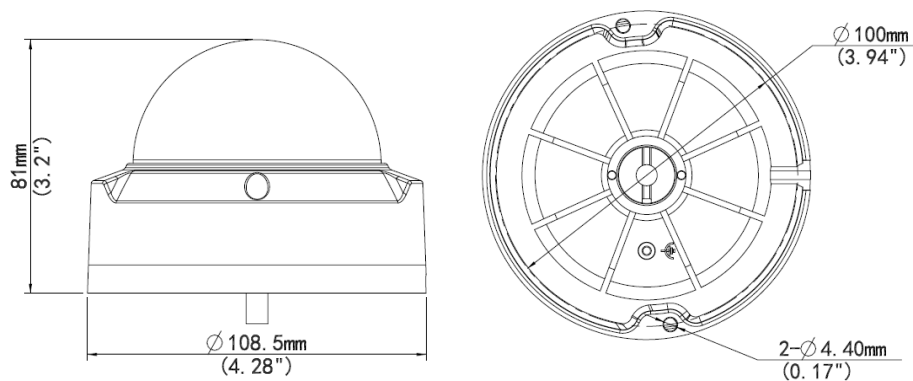

Accessories

TR-JB03-G-IN



TR-A01-IN

TR-JB07/WM03-G-IN



TR-UP06-IN

TR-WM03-D-IN

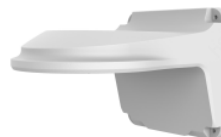

TR-SE24-IN

TR-UM06-E-IN



TR-SE24-A-IN



TR-CM24-IN

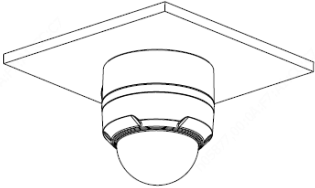
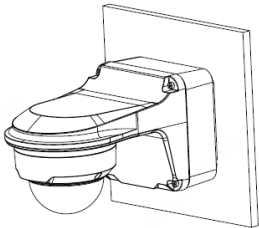
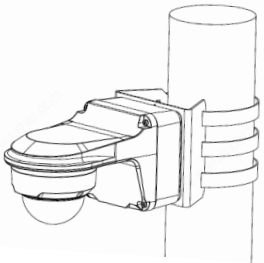
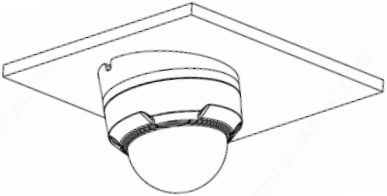

Junction box	Wall mount(Junction box)
TR-JB03-G-IN+TR-A01-IN	TR-JB07/WM03-G-IN(TR-WM03-D-IN)+TR-A01-IN
	
Pole mount	Tilted mounting
TR-JB07/WM03-G-IN(TR-WM03-D-IN)+TR-A01-IN+ TR-UP06-IN	TR-UM06-E-IN
	
Indoor pendent mount	
TR-JB03-G-IN+TR-A01-IN + TR-SE24-IN(TR-SE24-A-IN)+ TR-CM24-IN	

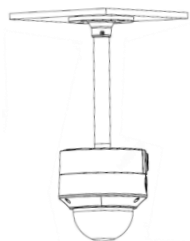
**Zhejiang Uniview Technologies Co., Ltd.**

Building No.10, Wanlun Science Park, Jiangling Road 88, Binjiang District, Hangzhou, Zhejiang, China (310051)

Email: overseasbusiness@uniview.com; globalsupport@uniview.com

<http://www.uniview.com>

©2019 Zhejiang Uniview Technologies Co., Ltd. All rights reserved.

*Product specifications and availability are subject to change without notice.